

Futterrohr
mit Klebe- /
Anschweiß-
flansch

FHRK-
Standard
30

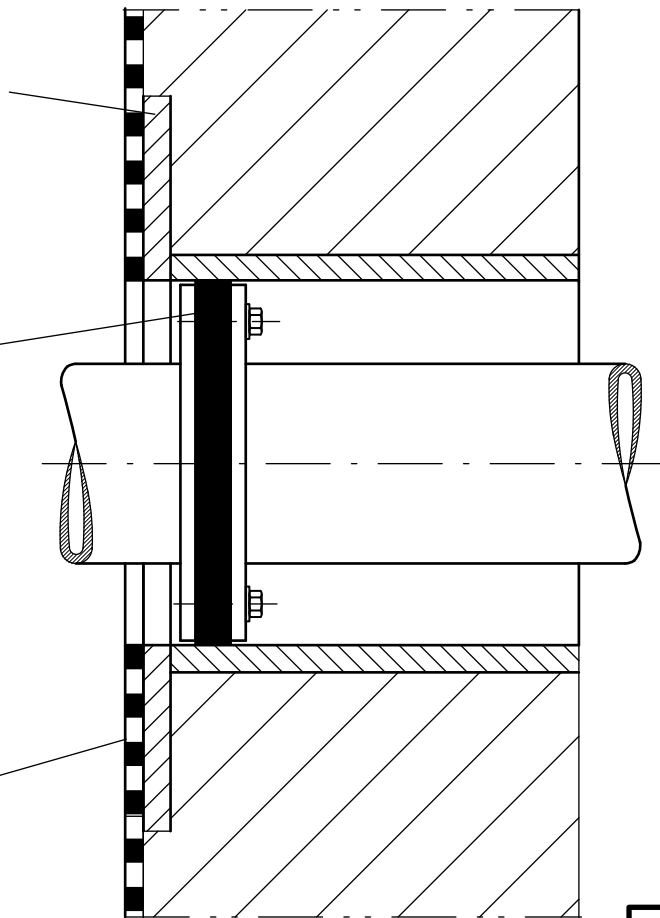

Außen-
abdichtung



2.1